

DATA SHEET INDUSTRIAL BRUSH SCRUBBY

Model:

200I

Category:

Industrial Brush

Dimensions : 1890 x 1000 x 400 mm forklift couplings included

L = 1890 mm

P = 1000 mm

h = 400 mm

Total weight: 280 kg

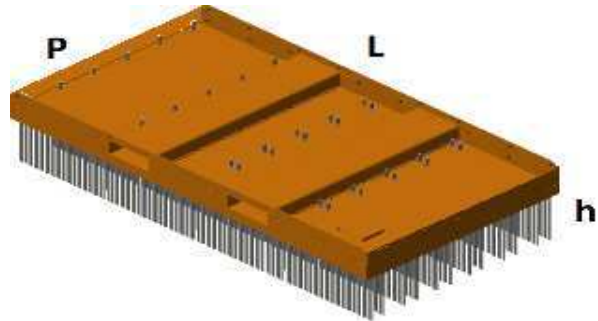

N.2 forklift couplings Fe360 dimensions:

i = 630 mm

a = 200 mm

b = 75 mm

**Components :**

Frame in Fe360, th. 3 mm, dim. 1890x1000 mm

Reinforcements sides in Fe360, th.5 mm welded on the borders

N.24 bolted iron plates made of 2 rows of steel strips

flat wire C45 3,3x0,6x260mm

N.1 security chain

Surface treatment: powder coating paint **Orange RAL 2004**

CE certificate – Operation and maintenance manual – Legal guarantee.

DATA SHEET INDUSTRIAL BRUSH SCRUBBY

Model:

201I

Category:

Industrial Brush

Dimensions : 1890 x 700 x 400 mm forklift couplings included

L = 1890 mm

P = 700 mm

h = 400 mm

Total weight: 230 kg

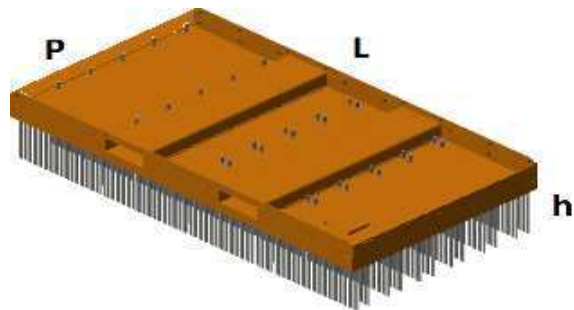

N.2 forklift couplings Fe360 dimensions:

i = 630 mm

a = 200 mm

b = 75 mm

**Components :**

Frame in Fe360, th. 3 mm, dim. 1890x700 mm

Reinforcements sides in Fe360, th.5 mm welded on the borders

N.20 bolted iron plates made of 2 rows of steel strips

flat wire C45 3,3x0,6x260mm

N.1 security chain

Surface treatment: powder coating paint **Orange RAL 2004**

CE certificate – Operation and maintenance manual – Legal guarantee.

DATA SHEET INDUSTRIAL BRUSH SCRUBBY

Model:

151I

Category:

Industrial Brush

Dimensions : 1450 x 700 x 400 mm forklift couplings included

L = 1450 mm

P = 700 mm

h = 400 mm

Total weight: 170 kg

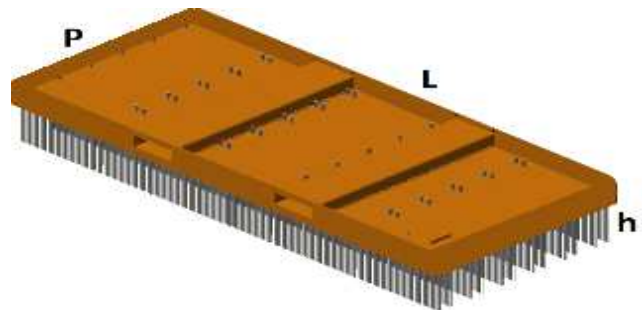

N.2 forklift couplings Fe360 dimensions:

i = 780 mm

a = 200 mm

b = 75 mm

**Components :**

Frame in Fe360, th. 3 mm, dim. 2360x700 mm

Reinforcements sides in Fe360, th.5 mm welded on the borders

N.15 bolted iron plates made of 2 rows of steel strips
flat wire C45 3,3x0,6x260mm

N.1 security chain

Surface treatment: powder coating paint **Orange RAL 2004**

CE certificate – Operation and maintenance manual – Legal guarantee.

DATA SHEET INDUSTRIAL BRUSH SCRUBBY

Model:

250I

Category:

Industrial Brush

Dimensions : 2360 x 1000 x 400 mm forklift couplings included

L = 2360 mm

P = 1000 mm

h = 400 mm

Total weight: 340 kg

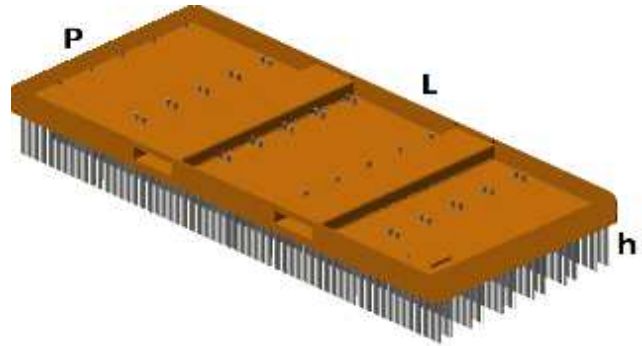

N.2 forklift couplings Fe360 dimensions:

i = 780 mm

a = 200 mm

b = 75 mm

**Components :**

Frame in Fe360, th. 3 mm, dim. 2360x1000 mm

Reinforcements sides in Fe360, th.5 mm welded on the borders

N.30 bolted iron plates made of 2 rows of steel strips
flat wire C45 3,3x0,6x260mm

N.1 security chain

Surface treatment: powder coating paint **Orange RAL 2004**

CE certificate – Operation and maintenance manual – Legal guarantee.

DATA SHEET INDUSTRIAL BRUSH SCRUBBY

Model:

251I

Category:

Industrial Brush

Dimensions : 2360 x 700 x 400 mm forklift couplings included

L = 2360 mm

P = 700 mm

h = 400 mm

Total weight: 285 kg

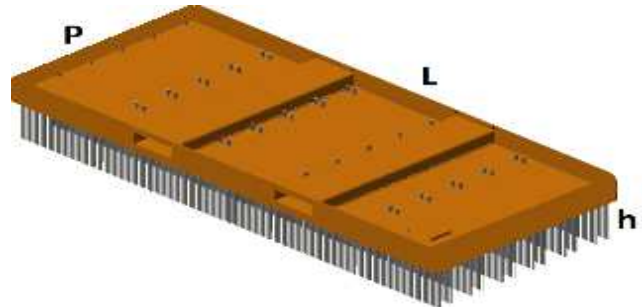

N.2 forklift couplings Fe360 dimensions:

i = 780 mm

a = 200 mm

b = 75 mm



Components :

Frame in Fe360, th. 3 mm, dim. 2360x700 mm

Reinforcements sides in Fe360, th.5 mm welded on the borders

N.25 bolted iron plates made of 2 rows of steel strips
flat wire C45 3,3x0,6x260mm

N.1 security chain

Surface treatment: powder coating paint **Orange RAL 2004**

CE certificate – Operation and maintenance manual – Legal guarantee.



LANZANI s.r.l.

Lanzani srl
Via Dalmazia, 5 - 20834 Nova M.se (MB)
P.I. IT00769950965 - C.F. 04070810157
Tel. +39 (0)362 450450
info@omlanzani.it - www.omlanzani.it



DATA SHEET INDUSTRIAL BRUSH SCRUBBY

Model:

200IR

Category:

Industrial Brush

Dimensions : 1890 x 1000 x 400 mm forklift couplings included

L = 1890 mm

P = 1000 mm

h = 400 mm

Total weight: 440 kg

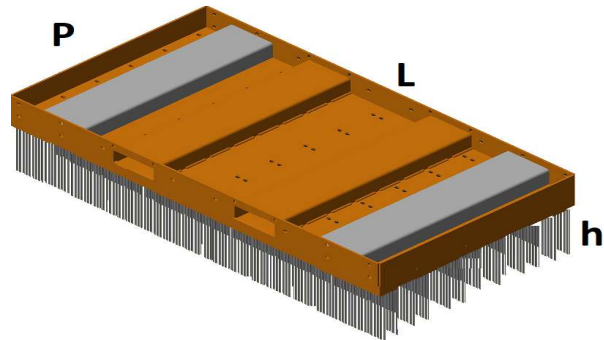

N.2 forklift couplings Fe360 dimensions:

i= 630 mm

a= 240 mm

b= 80 mm



Components :

Frame in Fe360, th. 8 mm, dim. 1890x1000 mm

Reinforcements sides in Fe360, th.8 mm welded on the borders

N.2 reinforcements tubulars th.8 mm

N.24 bolted iron plates made of 2 rows of steel strips

flat wire C45 3,3x0,6x260mm

N.1 security chain

Surface treatment: powder coating paint **Orange RAL 2004**

CE certificate – Operation and maintenance manual – Legal guarantee.

DATA SHEET INDUSTRIAL BRUSH SCRUBBY

Model:

250IR

Category:

Industrial Brush

Dimensions : 2370 x 1000 x 400 mm forklift couplings included

L = 2360 mm

P = 1000 mm

h = 400 mm

Total weight: 540 kg

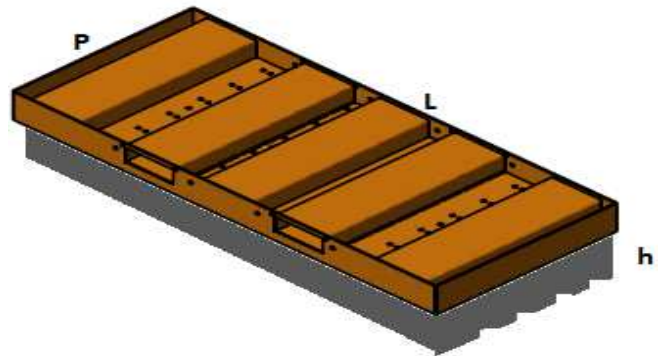

N.2 forklift couplings Fe360 dimensions:

i = 780 mm

a = 240 mm

b = 80 mm

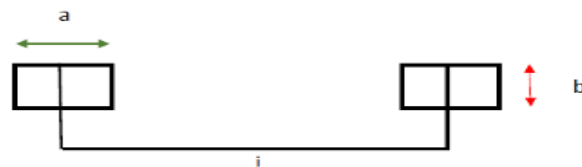
**Components :**

Frame in Fe360, th. 8 mm, dim. 2370x1000 mm

Reinforcements sides in Fe360, th.8 mm welded on the borders

N.3 reinforcements tubulars th.8 mm

N.30 bolted iron plates made of 2 rows of steel strips
flat wire C45 3,3x0,6x260mm

N.1 security chain

Surface treatment: powder coating paint **Orange RAL 2004**

CE certificate – Operation and maintenance manual – Legal guarantee.



Lanzani srl
Via Dalmazia, 5 - 20834 Nova M.se (MB)
P.I. IT00769950965 - C.F. 04070810157
Tel. +39 (0)362 450450
info@omlanzani.it - www.omlanzani.it

GENERAL FEATURES

MATERIALS

- All thicknesses have been calculated according to the size and capacity declared or required.
- Tolerance on dimensions: as per UNI tables relating to mechanical frames of average category work and equal to 3% of the value.
- Tolerance on nominal weight: as per UNI tables relating to ferrous materials used in 5% of nominal weight.
- Quality of finish: all our products are supplied without defects in their form, material, finish and with no burr.
- All our products are painted powder paints orange RAL 2004.

NB: pictures are purely indicative and may not exactly represent product features.

Lanzani srl reserves the right to modify, at any time and without notice, the execution and the sizes of the products shown.